

AD3-5 INSTRUCTIONS FOR USE





Thank you for having chosen an LAE electronic product. Before installing the instrument, please read this instruction booklet carefully in order to ensure safe installation and optimum performance.



DESCRIPTION





Fig.1 — Front panel

INDICATIONS

-  Thermostat output
-  Fan output
-  Defrost output
-  Activation of 2nd parameter set
-  Alarm

-  Info / Setpoint button.
-  Manual defrost / Decrease button.

-  Increase / manual activation button.
-  Exit / Stand-by button.

INSTALLATION

- Insert the controller through a hole measuring 71x29 mm.
- Make sure that electrical connections comply with the paragraph “wiring diagrams”. To reduce the effects of electromagnetic disturbance, keep the sensor and signal cables well separate from the power wires.
- Fix the controller to the panel by means of the suitable clips, by pressing gently; if fitted, check that the rubber gasket adheres to the panel perfectly, in order to prevent debris and moisture infiltration to the back of the instrument.
- Place the probe T1 inside the room in a point that truly represents the temperature of the stored product.
- Place the probe T2 on the evaporator where there is the maximum formation of frost.
- The function of probe T3 is determined by the parameter T3. With **T3=DSP** the probe measures the temperature to be displayed. With **T3=CND** the probe measures the condenser temperature, it must therefore be placed between the fins of the condensing unit. With **T3=2EU** the probe measures the temperature of the second evaporator and it must therefore be placed where there is the maximum formation of frost. With **T3=NON**, the third probe is disabled.

OPERATION

DISPLAY

During normal operation, the display shows either the temperature measured or one of the following indications:

DEF	Defrost in progress	HP	Condenser high pressure alarm
REC	Recovery after defrost	HI	Room high temperature alarm
OFF	Controller in stand-by	LO	Room low temperature alarm
CL	Condenser clean warning	E1	Probe T1 failure
DO	Door open alarm	E2	Probe T2 failure
HC	Condenser high temperature alarm	E3	Probe T3 failure

INFO MENU

The information available in this menu is:

T1	Instant probe 1 temperature	TLO	Minimum probe 1 temperature recorded
T2	Instant probe 2 temperature	CND	Compressor working weeks
T3	Instant probe 3 temperature	LOC	Keypad state lock
THI	Maximum probe 1 temperature recorded		

Access to menu and information displayed.

- Press and immediately release button **[i]**.
- With button **[v]** or **[a]** select the data to be displayed.
- Press button **[i]** to display value.
- To exit from the menu, press button **[x]** or wait for 10 seconds.

Reset of THI, TLO, CND recordings

- With button **[v]** or **[a]** select the data to be reset.
- Display the value with button **[i]**.
- While keeping button **[i]** pressed, use button **[x]**.

SETPOINT (display and modification of desired temperature value)

- press button **[v]** for at least half second, to display the setpoint value.
- By keeping button **[v]** pressed, use button **[v]** or **[a]** to set the desired value (adjustment is within the minimum **SPL** and the maximum **SPH** limit).
- When button **[v]** is released, the new value is stored.

STAND-BY

Button **[s]**, when pressed for 3 seconds, allows the controller to be put on a standby or output control to be resumed (with **SB=YES** only).

KEYPAD LOCK

The keypad lock avoids undesired, potentially dangerous operations, which might be attempted when the controller is operating in a public place. In the INFO menu, set parameter **LOC=YES** to inhibit all functions of the buttons. To resume normal operation of keypad, adjust setting so that **LOC=NO**.

SELECTION OF SECOND PARAMETER GROUP

It's possible to select control parameters between two different pre-programmed groups, in order for the fundamental control parameters to be adapted quickly to changing needs.

Changeover from Group I to Group II may take place manually by pressing button **[m]** for 2 seconds (with **IISM=MAN**), or automatically when heavy duty conditions are detected (with **IISM=HDD**), or when the auxiliary input DI2 is activated (**IISM=DI2**). The activation of Group II is signalled by the lighting up of the relevant LED on the controller display. If **IISM=NON**, switchover to group II is inhibited.

DEFROST

Automatic defrost. A defrost is started automatically as soon as the time set with parameter **DFT** has elapsed.

- **Timed defrost.** With **DFM=TIM** the timer increment is continuous and defrosts take place at regular intervals. For example, with **DFM=TIM** and **DFT=06**, a defrost will take place every 6 hours.
- **Optimised defrost.** With **DFM=FRO** the timer is only increased when the conditions occur for frost to form on the evaporator, until the time set with parameter **DFT** is matched. If the evaporator works at 0°C, defrost frequency depends on the thermal load and climatic conditions. With setpoints much lower than 0°C, defrost frequency mainly depends on the refrigerator operating time.
- **Defrost time count backup.** At the power-up, if **DFB=YES**, the defrost timer resumes the time count from where it was left off before the power interruption. Vice versa, with **DFB=NO**, the time count re-starts from 0. In stand-by, the accumulated time count is frozen.

Manual or remote defrost start. It's possible to manually start a defrost, by pressing button **[d]** for 2 seconds, or defrost may be started remotely, if **DI2=RDS**, through the making of the auxiliary contact DI2.

Defrost type. Once defrost has started, Compressor and Defrost outputs are controlled according to parameter **DTY**. If **FID=YES**, the evaporator fans are active during defrost.

Defrost termination. The actual defrost duration is influenced by a series of parameters.

- **Time termination:** **T2=NO** and **T3** different from 2EU: the evaporator temperature is not monitored and defrost will last as long as time **DTO**.

- Temperature monitoring of one evaporator: **T2=YES** and T3 different from 2EU. In this case, if the sensor T2 measures the temperature **DLI** before the time **DTO** elapses, defrost will be terminated in advance.
- Temperature monitoring of two evaporators: **T2=YES**, **T3=2EU**, **OAU=2EU**. This function is for the control of two independent evaporators and it switches off the individual heating of the evaporator which gets to temperature **DLI** first, waiting for the second evaporator to get to that temperature before the time **DTO** elapses (see figure).

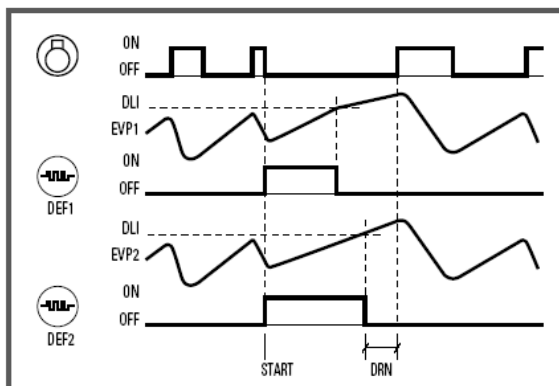

Resuming thermostatic cycle. When defrost is over, if **DRN** is greater than 0, all outputs will remain off for **DRN** minutes, in order for the ice to melt completely and the resulting water to drain. Moreover, if probe T2 is active (**T2=YES**), the fans will re-start when the evaporator gets to a temperature lower than **FDD**; Vice versa, if probe T2 is not active (**T2=NO**) or after defrost has come to an end, such condition does not occur by end of the time **FTO**, after **FTO** minutes have elapsed the fans will be switched on anyway.

*Caution: if **DFM=NON** or **C-H=HEA** all defrost functions are inhibited; if **DFT=0**, automatic defrost functions are excluded. During a high pressure alarm, defrost is suspended. During defrost, high temperature alarm is bypassed.*

CONFIGURATION PARAMETERS

- To get access to the parameter configuration menu, press button **☒+i** for 5 seconds.
- With button **▼** or **▲** select the parameter to be modified.
- Press button **i** to display the value.
- By keeping button **i** pressed, use button **▼** or **▲** to set the desired value.
- When button **i** is released, the newly programmed value is stored and the following parameter is displayed.
- To exit from the setup, press button **☒** or wait for 30 seconds.

WIRING DIAGRAMS

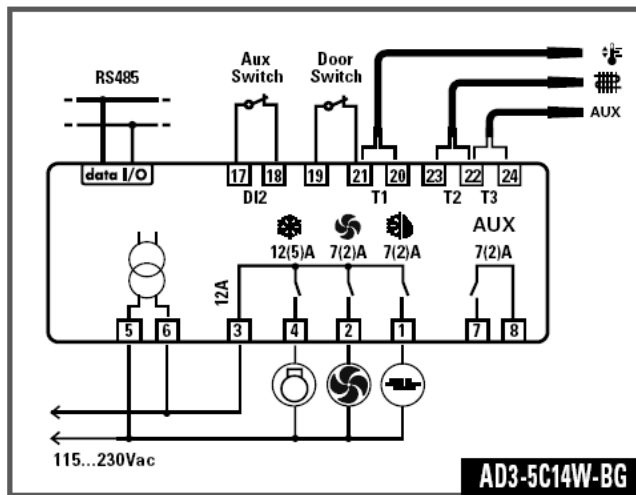
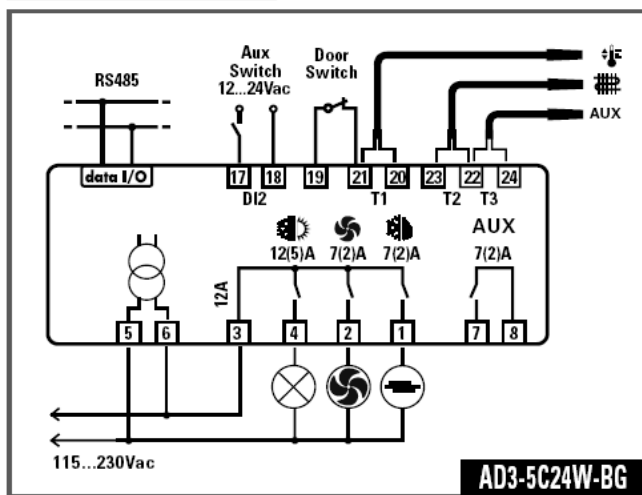

TECHNICAL DATA

Power supply

AD-3...D	12Vac±10%, 50/60Hz, 3W
AD-3...W	110 - 230Vac±10%, 50/60Hz, 3W

Relay outputs

Compressor	12(5)A 240Vac
Evap. fans	7(2)A 240Vac
Defrost	7(2)A 240Vac
Auxiliary loads	7(2)A 240Vac

Inputs

NTC 10K Ω @25°C,	LAE part No. SN4...
PTC 1000 Ω @25°C,	LAE part No. ST1...

Measurement Range

-50...120°C,	-55...240°F
--------------	-------------

Measurement accuracy

<0.5°C within the measurement range

Operating conditions

-10 ... +50°C;	15%...80% r.H.
----------------	----------------



CE (Reference Norms)

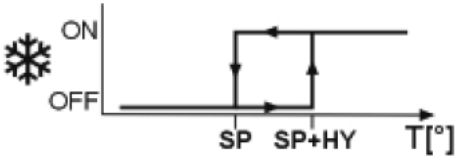
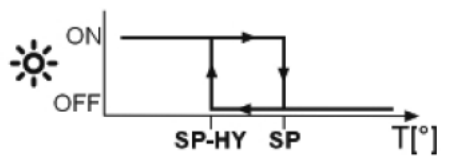

EN60730-1; EN60730-2-9;
EN55022 (Class B);
EN50082-1

Front protection

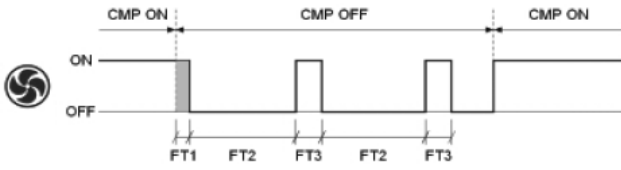
IP55

PAR	RANGE	DESCRIPTION
SCL	1°C; 2°C; °F	Readout scale. 1°C (only with INP=SN4): measuring range -50/-9.9 ... 19.9/80°C 2°C : measuring range -50 ... 120°C °F : measuring range -55 ... 240°F Caution: upon changing the SCL value, it is then <u>absolutely</u> necessary to reconfigure the parameters relevant to the absolute and relative temperatures (SPL, SPH, SP, ATL, ATH, etc..)
SPL	-50..SPH	Minimum limit for SP setting
SPH	SPL..120°	Maximum limit for SP setting
SP	SPL... SPH	Setpoint (value to be maintained in the room).
C-H	REF; HEA	Refrigerating (REF) or Heating (HEA) control mode
HYS	1...10°	OFF/ON thermostat differential <div style="display: flex; justify-content: space-around; align-items: center;"> <div style="text-align: center;">  <p>Refrigerating control (C-H=REF)</p> </div> <div style="text-align: center;">  <p>Heating control (C-H=HEA)</p> </div> </div>
CRT	0...30min	Compressor rest time. The output is switched on again after CRT minutes have elapsed since the previous switchover. We recommend to set CRT=03 with HYS<2.0°.
CT1	0...30min	Thermostat output run when probe T1 is faulty. With CT1=0 the output will always remain OFF.
CT2	0...30min	Thermostat output stop when probe T1 is faulty. With CT2=0 and CT1>0 the output will always be ON. Example: CT1=4, CT2= 6: In case of probe T1 failure, the compressor will cycle 4 minutes ON and 6 minutes OFF.
CSD	0..30min	Compressor stop delay after the door has been opened (active only if DS=YES).
2CD	0...120sec	Auxiliary compressor start delay. If OAU = 2CU the auxiliary output is switched on with a delay of 2CD seconds after the main compressor has cut-in. Both compressors are turned off at the same time.
DFM	NON; TIM; FRO	Defrost start mode NON : defrost function is disabled (the following parameter will be FID). TIM : the defrost time count is increased continuously. FRO : the defrost time count is only increased when the conditions occur for frost to form on the evaporator (optimised time increase).
DFT	0...99 hours	Time interval among defrosts. When this time has elapsed since the last defrost, a new defrost cycle is started.
DFB	NO/YES	Defrost timer count backup. With DFB=YES, after a power interruption, the timer resumes the count from where it was left off with ±30 min. approximation. With DFB=NO, after a power interruption, the defrost timer will re-start to count from zero.
DLI	-50...120°	Defrost end temperature.
DTO	1...120min	Maximum defrost duration.
DTY	OFF; ELE; GAS	Defrost type OFF: off cycle defrost (Compressor and Heater OFF). ELE: electric defrost (Compressor OFF and Heater ON). GAS: hot gas defrost (Compressor and Heater ON).
DRN	0...30min	Pause after defrost (evaporator drain down time).
DDY	0...60min	Display during defrost. If DDY=0 during defrost the temperature continues to be displayed. If DDY > 0, during defrost the display shows DEF, when defrost is over REC is displayed during DDY minutes.

FID	NO/YES	Fans active during defrost.
FDD	-50...120°	Evaporator fan re-start temperature after defrost.
FTO	0...120min	Maximum evaporator fan stop after defrost.
FTC	NO/YES	Optimised fan control enabling. With FTC = NO the fans remain on all the time.  Fig.2 Optimised fan control (FTC=YES)
FT1	0...180sec	Fan stop delay after compressor stop. See Fig. 2
FT2	0...30min	Timed fan stop. With FT2 =0 the fans remain on all the time.
FT3	0...30min	Timed fan run. With FT3 =0, and FT2 > 0, the fans remain off all the time.
ATM	NON; ABS; REL	Alarm threshold management. NON: all temperature alarms are inhibited (the following parameter will be ADO). ABS: the values programmed in ALA and AHA represent the real alarm thresholds. REL: the values programmed in ALR and AHR are alarm differentials referred to SP and SP+HY.  Temperature alarm with relative thresholds, refrigerating control (ATM=REL, CH=REF). Temperature alarm with relative thresholds, heating control (ATM=REL, CH=HEA).
ALA	-50... 120°	Low temperature alarm threshold.
AHA	-50... 120°	High temperature alarm threshold.
ALR	-12... 0°	Low temperature alarm differential.
AHR	0... 12°	High temperature alarm differential.
ATI	T1; T2; T3	Probe used for temperature alarm detection.
ATD	0... 120min	Delay before alarm temperature warning.
ADO	0... 30min	Delay before door open alarm warning.
AHM	NON; ALR; STP;	Operation in case of high condenser alarm NON: high condenser alarm inhibited. ALR: in case of alarm, "HC" flashes in the display and the buzzer is switched on. STP: in addition to the alarm symbols displayed, the compressor is stopped and defrosts are suspended.
AHT	-50...120°	Condensation temperature alarm.
ACC	0...52 weeks	Condenser periodic cleaning. When the compressor operation time, expressed in weeks, matches the ACC value programmed, "CL" flashes in the display.
HDS	1...5	Controller sensitivity for the automatic switchover from Group 1 to Group 2 (1=minimum, 5=maximum)
IISM	NON; MAN; HDD; DI2	Switchover mode to second parameter set NON: inhibition to use the second parameter group (the following parameter will be SB). MAN: button  switches the two parameter groups over. HDD: automatic switchover to the second parameter group, when heavy duty conditions are detected. DI2: switchover to the second parameter group when the auxiliary DI2 input makes.

IISL	-50...IISH	Minimum limit for IISP setting.
IISH	IISL...120°	Maximum limit for IISP setting.
IISP	IISL... IISH	Setpoint in mode 2.
IHY	1...10°	OFF/ON differential in mode 2.
IIFT	NO/YES	Optimised fan control enabling in mode 2.
IIDF	0...99 hours	Defrost timer set to start a defrost in mode 2.
SB	NO/YES	Stand-by button enabling  .
DS	NO/YES	Door switch input enabling (closed when door is closed).
DI2	NON; HPS; IISM; RDS	DI2 digital input operation NON : digital input 2 not active. HPS: when contact opens a condensing unit high pressure alarm occurs. IISM : when contact makes the controller will use group 2 parameters. RDS : when contact makes a defrost is started (remote control).
LSM	NON; MAN; DOR	Light control mode NON : light output not controlled. MAN : light output controlled through button  (if OAU =LGT). DOR : light output switched on when door is opened (if OAU =LGT).
OAU	NON; 0-1; LGT; 2CU; 2EU; AL0; AL1	AUX output operation NON : output disabled (always off). 0-1 : the relay contacts follow the on/standby state of controller. LGT : output enabled for light control. 2CU : output programmed for the control of an auxiliary compressor. 2EU : output enabled for the control of the electrical defrost of a second evaporator. AL0 : contacts open when an alarm condition occurs. AL1 : contacts make when an alarm condition occurs.
INP	SN4; ST1	Temperature sensor selection. With INP = SN4, the probes must be the LAE models SN4...; with INP = ST1, the probes must be the LAE models ST1...
OS1	-12.5..12.5°C	Probe T1 offset.
T2	NO/YES	Probe T2 enabling (evaporator).
OS2	-12.5..12.5°C	Probe T2 offset.
T3	NON; DSP; CND; 2EU	Auxiliary probe T3 operation NON: probe T3 not fitted. DSP: temperature T3 to be displayed. CND: condenser temperature measurement. 2EU: second evaporator temperature measurement.
OS3	-12.5..12.5°C	Probe 3 offset.
TLD	1...30 min	Delay for minimum temperature (TLO) and maximum temperature (THI) logging.
SIM	0...100	Display slowdown.
ADR	1...255	AD3-5 address for PC communication.